



# Gask-O-Seal<sup>®</sup> and Integral Seal<sup>™</sup> Design Handbook

aerospace  
climate control  
electromechanical  
filtration  
fluid & gas handling  
hydraulics  
pneumatics  
process control  
sealing & shielding



ENGINEERING YOUR SUCCESS.



## WARNING

FAILURE OR IMPROPER SELECTION OR IMPROPER USE OF THE PRODUCTS AND/OR SYSTEMS DESCRIBED HEREIN OR RELATED ITEMS CAN CAUSE DEATH, PERSONAL INJURY AND PROPERTY DAMAGE.

This document and other information from Parker Hannifin Corporation, its subsidiaries and authorized distributors provide product and/or system options for further investigation by users having technical expertise. It is important that you analyze all aspects of your application and review the information concerning the product or system in the current product catalog. Due to the variety of operating conditions and applications for these products or systems, the user, through its own analysis and testing, is solely responsible for making the final selection of the products and systems and assuring that all performance, safety and warning requirements of the application are met.

The products described herein, including without limitation, product features, specifications, designs, availability and pricing, are subject to change by Parker Hannifin Corporation and its subsidiaries at any time without notice.



# Gask-O-Seal<sup>®</sup> and Integral Seal<sup>™</sup> Design Handbook



## Table of Contents

### Introduction

Static Face Seals.....	2
Elastomer Materials.....	4
Retainer Materials .....	5
Metal Finish Considerations .....	6
Operating Conditions.....	7

### Gask-O-Seal

About Gask-O-Seals .....	8
Gask-O-Seal Design Considerations .....	9
Gask-O-Seal Configurations .....	11

### Integral Seal

About Integral Seals .....	12
Integral Seal Design Considerations .....	13
Integral Seal Configurations .....	15

### Technical Data and Product Information

Chemical Compatibility Guide .....	16
Leak Rate Criteria .....	18
Bolt Sizes and Torque Values .....	19
Application Data Form.....	20

# Introduction

## Static Face Seals

There are many types of static face sealing methods: **liquid sealants**, flat gasket, seal elements in grooves, metal shapes, and molded-in-place seals. The *flowable* types of sealing materials, such as caulks, RTVs, or cements, have been developed as alternatives to the flat gasket. Generally, pressure containment capabilities are low (<20 psi), and compatibility and environmental demands in such applications are not too stringent. These are easy to use and inexpensive to purchase. However, there are number of disadvantages in using these types of seals:

1. Inconsistent volume of sealing material dispensed
2. Poor appearance on hardware
3. Requires an in-plant cure time before pressure testing
4. Limited pressure capability; i.e., <20 psi
5. Limited long-term sealability
6. Labor intensive and time consuming to cleanup during disassembly
7. Difficult maintenance of hardware due to sealant cleanup

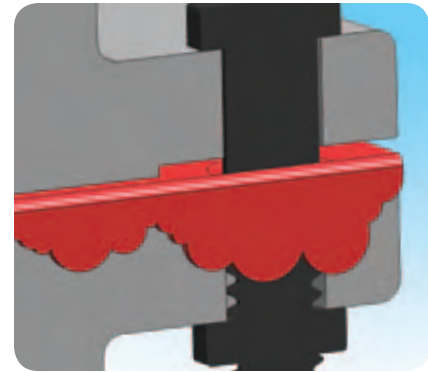

Liquid Sealants

The **flat gasket** is the oldest and most popular way to seal a flange or joint. The gasket is stamped, cut, or formed to size from suitable materials which are often on hand. It is squeezed between the mating surfaces as they are clamped or bolted together. Depending on the joint requirements, the gasket material selection can range anywhere from treated paper to various rubber/fiber compositions, to somewhat more sophisticated wrapped and formed metal composites. Where reusability is not required and where the possibility of some leakage can be tolerated, the flat gasket may be the best choice. However, this approach has several limitations:

1. High bolt loading is required to achieve seating of the gasket
2. Material is subject to cold flow and squeeze out
3. Periodic retorquing is required to maintain a seal because of compression set
4. The gasket may swell and disintegrate due to the absorption of fluid
5. Poor sealing capabilities – “seepage and weepage”



Flat Gaskets

The **molded shape** represents a marked improvement over the flat gasket for applications where little or no leakage can be tolerated. The resilient rubber type sealing element on O-ring shape provides narrow “line of contact sealing” for improved sealing and lowered compression force, and it is available in various sizes and compounds. There are some other things to consider before using an O-ring as a sealing element:

1. Requires precise groove machining and smooth groove finish
2. Difficult installation for vertical or upside down gland
3. Snaking or stretching of O-ring during assembly
4. Unable to confirm installation of the O-ring after joint assembly
5. A large surface area of the O-ring is exposed to fluid attack
6. Pressure fluctuations can cause portions of the O-ring to be extruded

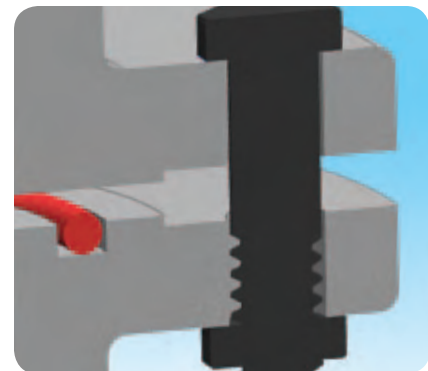

Molded Shape

The **metal shape** seals can be divided into metal gaskets and resilient metal seals. The metal gaskets are essentially crush type sealing devices, available in a variety of corrugated and jacketed designs for extreme temperatures and corrosive environments. The resilient metal seals are high-performance, precision devices, either machined or formed in circular configuration for resistance to temperature extremes and highly corrosive environments. Please see Parker's Engineered Metal Sealing Solutions for Extreme Environments, catalog CSS 5119, for more information about metal seals.

1. Requires precise groove machining and smooth groove finish
2. Difficult installation for vertical or upside down gland
3. Unable to confirm installation of metal seal after joint assembly
4. Requires higher compression load than the molded shape elastomeric seals
5. Can produce high forces against mating hardware

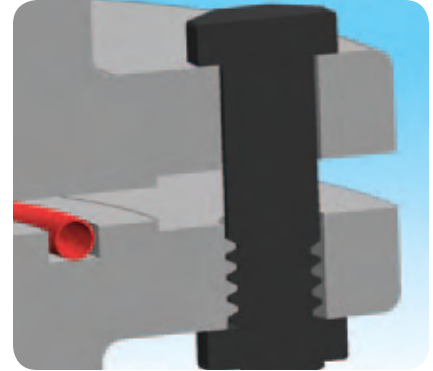

Metal Shape

The molded in place sealing element, **Gask-O-Seal** or **Integral Seal**, represents a significant improvement over both the flat gasket and the molded shape in a groove for near zero leakage static sealing:

**Gask-O-Seal Features and Benefits:**

1. Sealing element molded precisely in place with controlled void-volume ratio and squeeze for optimum sealing
2. Limited area of seal exposed to fluid/chemical attack
3. Multiple-port and complex shapes sealing capability
4. Reduced number of sealing parts and installation time
5. Visually detectable after assembly, eliminating possibility of errors and omissions
6. No retorquing required, metal-to-metal contact ensures positive closure and optimum bolt loading
7. Segmented seal designs available for extremely large sizes and simplified packaging and shipping
8. Reusability is possible, consistent with the overall condition of the seal after service
9. Eliminates the need for machined grooves



Gask-O-Seal

**Integral Seal Features and Benefits:**

1. Low cost for high volume applications
2. Multiple-port and complex shapes sealing capability.
3. Reduced number of sealing parts and installation time
4. Visually detectable after assembly, eliminating possibility of errors and omissions
5. No retorquing required, metal-to-metal contact ensures positive closure and optimum bolt loading
6. No special machining required
7. Reusability is possible, consistent with the overall condition of the seal after service
8. Can be retrofitted to existing O-ring grooves or counterbores
9. Eliminates the need for machined grooves
10. Retainer thickness as low as .012"

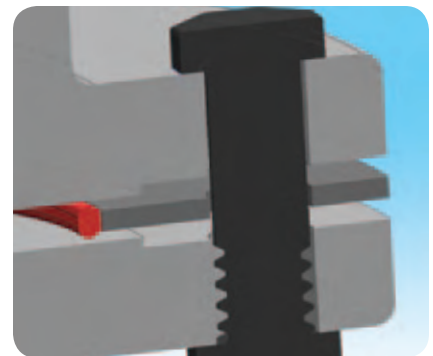

Integral Seal

# Introduction

## Elastomer Materials

The materials listed below are commonly recommended compounds for most seal applications. For more comprehensive information on service recommendations, see the fluid compatibility tables beginning on page 16. For more

information about approved polymers in UL, FDA, USDA, USP Class 6, NSF 51, NSF 61, USP, AMS, NAS and MS, please contact the division for technical support.

Polymer (Abbreviation)	Color	Applications	Temperature Range °F (°C)	Relative Cost 10 = High 1 = Low
Butyl (IIR)	Black	Low permeability rate and good electrical properties. Often used to seal low temperature vacuum system applications.	-75° to 250° (-59° to 121°)	2
Ethylene Acrylic (AEM)	Black	Similar to polyacrylate with improved low temperature performance, swells more in oil than polyacrylate. Resistance to weathering ozone and air aging.	-40° to 350° (-40° to 177°)	1
Ethylene Propylene (EPDM, EPM)	Black Purple	Widely specified seal material – excellent resistance to water, steam, alcohols, ketones, brake fluid, skydrol and other phosphate ester based hydraulic fluids. Not for petroleum fluids and diester base lubricants.	-70° to 300° (-57° to 149°)	1
Fluorocarbon (FKM, FPM)	Black Brown Green Red White	Wide spectrum chemical resistance and broad temperature range. Excellent permeability and compression set. Good in petroleum oils, acids, silicone fluids and greases.	-15° to 400° (-26° to 204°)	5
Fluorosilicone (FVMQ)	Blue Rust	Combines temperature range of silicone with good resistance to petroleum-based fuels and lubricants. Applications with high heat that are combined with potential exposure to petroleum oils and/or hydrocarbon fuels.	-100° to 350° (-73° to 177°)	6
Highly Fluorinated Elastomers (FKM)	Black Translucent White	For high purity sealing applications that require low particle generation, low extractables and improved resistance to aggressive chemistries as compared to FKM.	-15° to 400° (-26° to 204°)	8
Hydrogenated Nitrile (HNBR, HSN)	Black Green Red	Similar to nitrile with improved high temperature capabilities and ozone resistance. Excellent resistance to petroleum-based fluids. Ideal for automotive applications.	-40° to 325° (-40° to 163°)	4
Neoprene (CR)	Black Red	Exhibits good ozone, aging and chemical resistance – primarily used in refrigerants.	-40° to 250° (-40° to 121°)	2
Nitrile or Buna-N (NBR)	Black	Most widely used polymer in the seal industries. Excellent resistance to petroleum-based fluids, good balance of physical properties and wide temperature range. Outstanding resistance to compression set, cold flow, tear and abrasion.	-65° to 250° (-54° to 121°)	1
Perfluoro-elastomer (FFKM, FFKM)	Black White Translucent	Excellent chemical resistance and high thermal stability. Not to be exposed to molten or gaseous alkali metals, such as sodium and potassium. Recommended for highly aggressive chemical processing and semiconductor wafer processing.	5° to 600° (-15° to 316°)	10
Polyacrylate (ACM)	Black	Outstanding resistance to petroleum-based fuels and oils. Good resistance to oxidation, ozone and sunlight – resists flex cracking.	-5° to 350° (-21° to 177°)	3
Silicone (PVMQ, VQM)	White Rust Translucent	Excellent resistance to temperature extremes and compression set. Good insulating properties and abrasion resistance. Relatively poor tensile strength and tear resistance. Not recommended for petroleum fluids, ketones, water and steam.	-175° to 450° (-115° to 232°)	2

**NOTE:** Due to the variety of operating conditions and applications for these products or systems, the user, through its own analysis and testing, is solely responsible for making the final selection of the products and systems and assuring that all performance, safety and warning requirements of the applications are met.

## Retainer Materials

The retainer material has a direct bearing on the ultimate performance and cost of the Gask-O-Seal and Integral Seal. Generally speaking, Gask-O-Seals and Integral Seals can be furnished in any rigid, heat stable material, either flat or contoured. The table below covers

a variety of the more common metals and plastics from which Gask-O-Seals and Integral Seals can be made, along with a listing of their important properties.

Retainer Material	Applications	Ult. Tensile (Ksi)	Relative Cost 10 = High 1 = Low
<b>Aluminum</b>	Aluminum alloys are attacked by strong acids and alkalis, but are resistant to many organic acids and other organic compounds. Aluminum alloys are resistant to commercial hydrocarbon oils and aircraft fuels. The 6061 alloy is relatively resistant to sea water, marine and industrial atmospheres. Some elastomers require long time high temperature curing cycles which cause heat treated alloys as used in a Gask-O-Seal and Integral Seal to lose some of their temper.	45 to 82	1
<b>Copper &amp; Copper Alloys</b>	Copper alloys are sometimes used in Gask-O-Seals because of their reasonable cost and good corrosion resistance to water and numerous chemical solutions. Copper alloys are attacked by strong acids, but are resistant to organic acids, sea water, organic chemicals, and oils. Where severe conditions exist, low zinc bronzes can be used for better corrosion resistance.	35 to 100	3
<b>Die Cast</b>	For many demanding high volume applications, metal die cast represents a good substrate choice. With a variety of metal geometries, the die cast retainer can be configured to handle the rigors of any high pressure application.	–	5
<b>Inconel</b>	Inconel has excellent corrosion resistance and high operating temperature (1200°F max.).	160	8
<b>Magnesium</b>	Magnesium has poor corrosion resistance in the presence of moisture, and it is considered inferior to aluminum in corrosion resistance. With surface treatments such as H.A.E. or DOW 17, it can be used in mildly corrosive conditions such as marine atmospheres, oils, and acid-free hydrocarbons.	40	2
<b>PEEK</b>	Use of these materials is limited to those grades that can withstand molding temperatures and pressures along with being resistant to deterioration and wicking in certain media.	–	5
<b>Powdered Metal</b>	For a low cost metal fabrication method, powdered metal can be considered. Powdered metal can be pressed into the desired shape and then sintered in an oven to make it impact resistant and very strong.	–	5
<b>Stainless Steel</b>	The stainless steels vary in their corrosion resistance depending on the type of stainless. The non-heat treatable 300 series steels have the best corrosion resistance of the common steels. The 304 type steel has been used extensively for organic acids, and to a lesser degree for sulfuric acid. It is resistant to a wide variety of salt solutions and organic chemicals.	75 to 110	4
<b>Steel</b>	The corrosion properties of carbon steels are poor and they require plating where corrosion must be minimized. With plating, it can be used in corrosive media such as hot water, hot oils, and various organic compounds.	45 to 125	2
<b>Titanium</b>	Titanium has high tensile strength, light weight, extraordinary corrosion resistance, and ability to withstand extreme temperatures. For these reasons, titanium alloys are used in aircraft, armor plating, naval ships, spacecraft and missiles. It is also used to make various components for desalination and submarines due to excellent resistance to sea water.	90	10

# Introduction

## Metal Finish Considerations

Parker prefers to apply protective coatings to customer furnished parts rather than leave this to the customer. If the customer applies the coating before sending parts to Parker, the coating may be damaged in the shipping or molding process. In addition, if we cut the groove, it too will not receive the corrosion protective

treatment. If a coating is applied after the rubber has been molded, cleaning or plating solutions may damage the rubber. There is also the danger that corrosive solutions may become trapped under the rubber, causing damage to the retainer.

Finish	Metal	Coating Thickness (Inches)	Color	Remarks
<b>Anodize</b>	Aluminum	.00002 – .0024	Clear All colors	Excellent bonding characteristics, good corrosion resistance, and low cost.  Type I coating is non-conductive, poor abrasion resistance, and not good for dyes except black. Type I has coating thickness of .00002" to .0003", so it is typically used for close tolerance parts. Type II has good abrasion resistance, electrical barrier, and paint base. Not to be applied to assemblies or parts with joints or recesses which might entrap sulfuric acid solution. Type III has outstanding thermal and electrical barrier and wear resistance. Coatings are approximately 50% penetration and 50% buildup.
<b>Cadmium</b>	All	.00002 – .00005	Clear, gold, green, black, gray gull, and bright	Good bonding characteristics, corrosion resistance, and electrical conductivity. Type I coating is very susceptible to stains and fingerprints. Type II coating is excellent for resistance to moisture, humidity, and paint base. Type III is a good paint base. Cadmium is considered hazardous substance, and it is not compliant to RoHS (Restriction on Hazardous Substances).
<b>Chemical Films (Alodine, Iridite, etc.)</b>	Aluminum	No dimensional change	Gold or clear as specified	Used mainly as a paint base that improves paint adhesion. Good corrosion resistance and electrical conductivity. Normally gold color unless otherwise specified. AMS-C-5541 Class 1A coating is for maximum protection against corrosion, and Class 3 is primarily for low electrical resistance contact.
<b>Chromium</b>	All	.00001 – .002	Dull to bright	Excellent wear and abrasion resistance, reduced friction, and prevent galling. Good corrosion resistance. Brightness and type of finish depend upon basis metal preparation. Bright chrome is often used as a decorative feature on consumer products. There are two types of industrial chrome plating solutions: hexavalent and trivalent chromium. Only trivalent is compliant to RoHS.
<b>Electroless Nickel</b>	All	.0005 – .0015	Semi-bright	Excellent corrosion, oxidation and wear resistance. Very smooth surface with natural lubricity without any porosity. Anti-galling characteristics for mating metallic substrates. Overall uniformity of deposit with no edge buildup. Exceptionally good for salvage purposes.
<b>Nickel</b>	All	.0002 – .003	Dull to bright	Nickel is electrodeposited (plated) to provide a decorative appearance because of its ability to cover imperfections in the base metal (leveling). Low thermal expansion. Slightly magnetic. Better wearability than softer metals such as copper or zinc.
<b>Passivate</b>	Stainless Steel	No dimensional change	No appearance change	Dissolves all traces of foreign materials such as pieces of iron particles, tool scrapings, chips, etc. that will cause rust or stain spots. Process purifies surface and therefore improves corrosion resistance.
<b>Silver</b>	All	.0003 – .0005	Silver	Excellent electrical and thermal conductivity and decorative uses. Has unique properties including its strength, ductility, high reflectance of light, and ability to endure extreme temperature ranges.
<b>Zinc</b>	All	.0002 – .001	Clear, gold, gray, dull to bright	Zinc plating is a soft, decorative, corrosion and galvanic resistant finish. Good temperature resistance and electrical properties. The zinc coating can be attacked or dissolved by ordinary liquids such as soft drinks and vinegar.



# Operating Conditions

Material selection depends on the total environmental spectrum in which any given seal will perform. Thorough analysis of seal function should always begin with a consideration of the four major operating conditions:

## 1. Media

Always consider *all* media that may come in contact with the seal and retainer. For example, if the system is to be cleaned or purged periodically, be sure to anticipate what cleaning fluids will be used. These secondary fluids will play as much a role in selecting the most compatible compound as will the principal operating media. Refer to the media tables for the optimum compound choice. If you do not find your particular fluid listed, consult the Composite Sealing Systems Division for their recommendation.

## 2. Pressure

Proper seal design will provide Gask-O-Seals capable of withstanding extremely high pressures (e.g., some Gask-O-Seals have been tested to pressures over 20,000 psi). Similarly, reliable Gask-O-Seal configurations can be achieved for extremely low pressure levels, ultra hard vacuums down to  $10^{-9}$  torr range. It is essential that complete pressure data be submitted with all inquiries to assure optimum seal design. This includes maximum and minimum pressures, proof pressures, burst pressure, cycling conditions and pulsations.

Note: Extremely high pressure situations demand adequately structured mating assemblies to maintain metal to metal contact and prevent extrusion of the elastomer.

## 3. Temperature

Temperature is often the most misunderstood and exaggerated of the environmental parameters. It is all too often over specified. It should always be kept in mind that temperature at the seal itself may vary widely from the ambient condition (sometimes by hundreds of degrees). For example: The seal surrounding a water cooling port may never get over 200°F, whereas the temperature in a combustion chamber a mere ¼" away may easily exceed 1,000°F. Once a realistic temperature range has been ascertained at the seal interface, reference should again be made to the elastomer materials table for the optimum material selection.

Parker has applied a realistic temperature range with a margin of built-in safety in setting the general operating temperature limits. Thus, the maximum temperature stipulated for a given compound indicates that the compound will function satisfactorily for 1,000 hours or more at that temperature in air. Low temperature performance, on the other hand, involves a somewhat different consideration, the inherent flexibility of the chosen material and its ability to maintain an adequate sealing line of contact.

## 4. Time

The fourth major determinant in material selection is time. Brief temperature excursions up to a temperature level higher than those enumerated in the tables are often tolerable.

Example: A standard Buna-N (Nitrile) compound is normally recommended for service up to 225°F. However, this same Nitrile may withstand a much higher temperature for brief periods of time, and has been known to seal satisfactorily at 600°F for a few minutes.

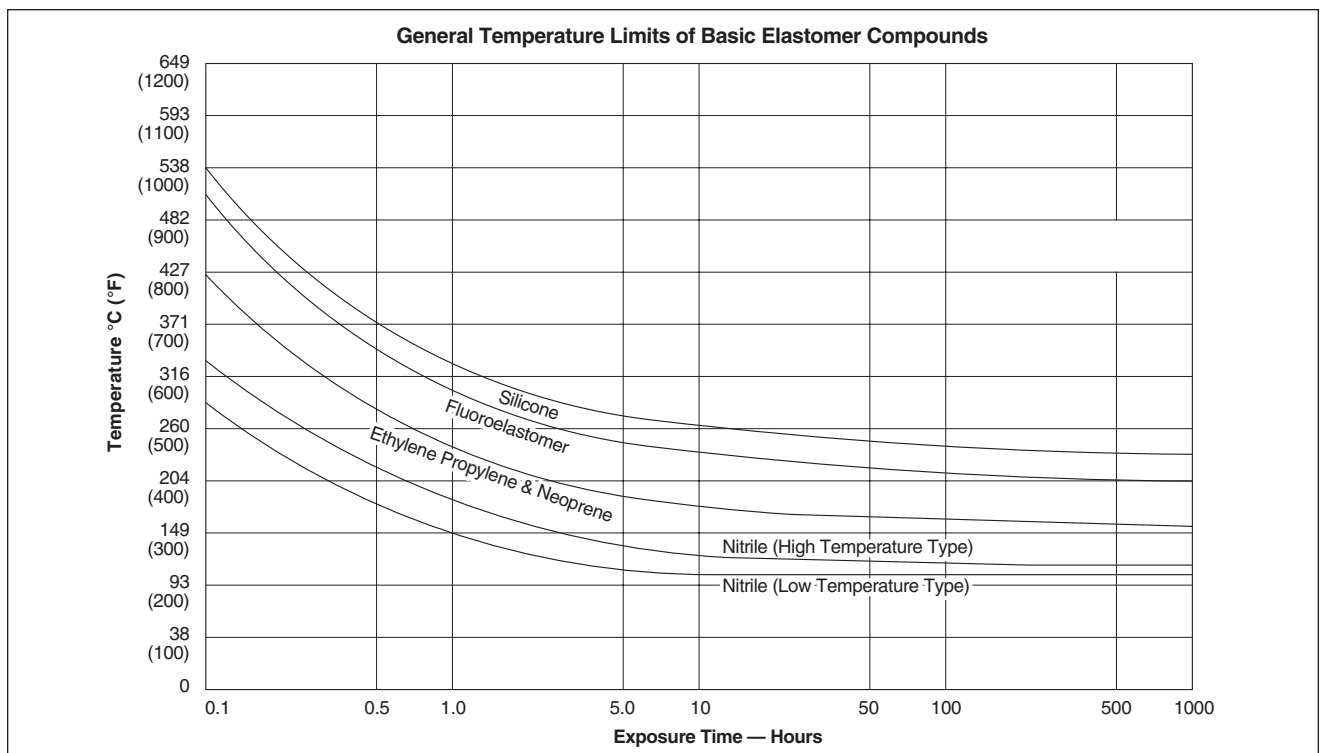

# Gask-O-Seal

## About Gask-O-Seal

The Parker Gask-O-Seal, now more than 55 years old, enjoys a leading role as a world class sealing concept. Profoundly simple, yet enviably reliable, a uniquely designed elastomeric element is molded directly into groove(s) to produce an integrated sealing solution for a virtually endless array of challenging static face type applications.

Under pressure of assembly, the rubber compound is deformed from a round configuration to a square or oblong shape as shown in the figure. By predetermining and manufacturing the proper ratio between

the volume of the molded in voids and the volume of the crown, controlled confinement is obtained. The Gask-O-Seal is designed so that the elastomer is deformed against the faying surfaces, affecting the seal by the inherent “memory” or resiliency of the elastomer as it tries to return to its original molded shape. There are many features and benefits that come with Gask-O-Seal design in static face seal applications.

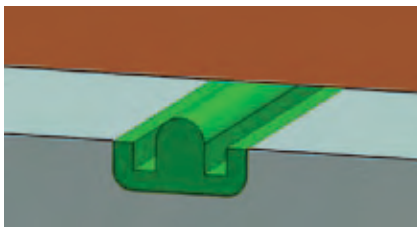

Before Loading

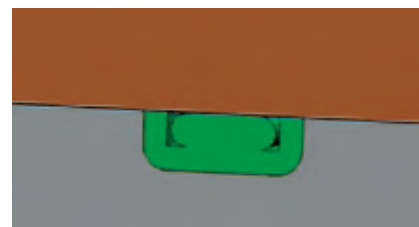

After Loading

Features		Benefits
Molded in Place		Sealing element precisely and permanently molded in place, allowing for ease of assembly. Secondary machining in mating hardware is not required, reducing hardware costs.
Volume/Void Ratio		Provides the most optimum setting for the fully compressed seal element during assembly – no over fill and no under fill.
Visual Detection		Can be visually inspected to verify proper assembly.
Point Loading of Seal		Permits reduced flange thickness, smaller bolts and bolt circle. The force required to load the Gask-O-Seal metal to metal can be predetermined with closely controlled crown height.
Alternative Load Path		No retorquing required due to metal to metal contact. The load path established through the metal retainer assures positive closure and optimum bolt loading.
Limited Area of Attack		Limited area of seal exposure to fluid attack protects the elastomer and provides longer life. A mere 2% or less exposure of seal surface to the media.
Low Permeability		Yields extremely low permeability rate in vacuum and other gaseous applications with controlled percent squeeze and volume/void ratio.

# Gask-O-Seal Design Considerations

Once the operating parameters and leak rate criteria have been established and the appropriate sealing materials selected, the actual design for the Gask-O-Seal can be started. This section provides basic guidelines for designing the seal.

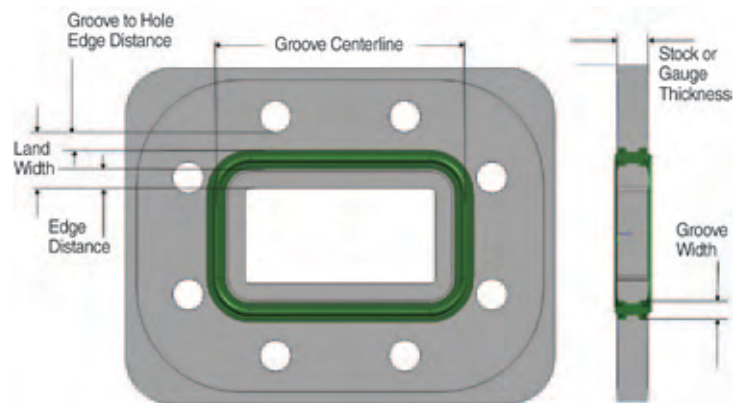

## 1. Edge Distance

Using standard metals and manufacturing techniques, the desired seal groove to edge distance is .060" minimum. The seal groove to hole distance can be as small as .050" minimum, providing the parts are not blanked. Blanked parts in low carbon steel require an edge distance at least as great as the thickness of the part. This is necessary because of the "roll" that occurs on the edges of blanked parts in this material.

## 2. Groove Design

It is good practice to use larger groove widths and higher crown heights for larger parts and higher pressures. It is recommended that customer's contact the Composite Sealing Systems Division's engineering department if the available land area is minimal. If adequate land area is available, .100" width is recommended.

## 3. Metal Thickness

Whenever possible, the metal thickness should be specified as a standard gauge callout with an accompanying standard stock thickness; i.e., Steel 11 gauge (.120" stock). This allows Parker to use materials that are readily available from suppliers and are most economical in producing the finished Gask-O-Seal. Metals with a thickness of less than .090" should be discussed with the Composite Sealing Systems Division's engineering department.

## 4. Dimensional Tolerances

In developing the overall design and establishing tolerances, the *non-critical* features, such as outline or outside dimensions, should have wide tolerances to reduce manufacturing costs. Bolt holes should have sufficient clearance around the bolts to permit reasonable locating tolerances. However, when the seal groove is located in relation to the bolt holes, the holes should be located within  $\pm 0.014$  on small parts (<10 inches). Broader location tolerances can be used if the groove width can be increased to allow for the resulting misalignment.

## 5. Bolting

In order to achieve optimum sealing, it is essential to provide sufficient flange preload and proper bolt size and spacing to create a metal to metal contact between the Gask-O-Seal retainer and the mating parts. Under all service conditions, such as out-of-flat, system pressure, and rubber strength, the separation between flanges should *not* exceed .003" in order to prevent extrusion and damage to the elastomer. The force required to compress the seal is generally between 30 and 150 pounds per linear inch of seal, depending on the rubber durometer, material, and the configuration used for larger gaps, contact the Composite Sealing Systems Division's engineering department.

## 6. Surface Roughness

Surface roughness of the Gask-O-Seal retainer itself is not critical to sealing. When a sheet metal retainer is used, the "as received" condition of the metal is satisfactory. On machined surfaces, Parker will maintain a roughness value of 125 micro-inch Ra or better. Callouts for finishes of the Gask-O-Seal retainer with roughness less than 125 Ra can add unnecessarily to the part cost. For mating surfaces that the Gask-O-Seal is to seal against, a 125 Ra or better will provide good sealing surfaces for almost all applications. The only notable exceptions are seals for gaseous media where diffusion type leakage must be kept to a minimum. For these installations, the mating surface should have a finish of 32 Ra or better.

## 7. Flatness and Parallelism

In most cases, no particular attention needs to be given to flatness and parallelism requirements. Occasionally a Gask-O-Seal is used between two halves of a device that must be accurately aligned such as a gear box housing. For this, the mating surfaces must be parallel within close tolerances. If the Gask-O-Seal is molded directly into one of these rigid parts, which would often be a casting, a flatness requirement is generally acceptable.

# Gask-O-Seal

## Gask-O-Seal Design Considerations, *Continued*

### 8. Types of Bond

There are two types of bonding to retain sealing element in groove(s); mechanical and chemical.

#### • Mechanical Bonding:

In a double sided retainer with back-to-back grooves, it is convenient to provide cross holes in the web portion at planned intervals. During the molding process, the rubber compound flows through these holes, mechanically locking and holding the seal elements in place.

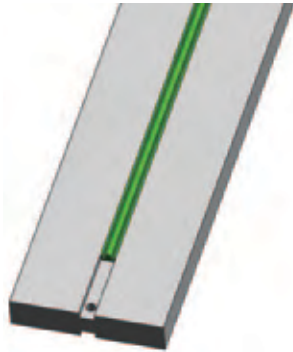

#### • Chemical Bonding:

A chemical bonding agent is applied to the groove(s) prior to molding. During the molding process, the rubber compound interacts with this bonding agent, a process called co-vulcanization, to chemically bond the seal element in place.

### 9. Finite Element Analysis (FEA)

The study of elastomer stress and its relationship to seal effectiveness has been dramatically enhanced with the advent of finite element analysis. FEA is a numerical modeling technique used to predict a deformation and stress concentration of a given seal cross section. Parameters such as cross section geometry and material property data are factored into the modeling equation to produce a stress concentration model of the seal. FEA is effective as a predictor of seal performance only when it is used in conjunction with historical seal and material data and specific performance testing. Please consult the division if FEA is being considered as a tool for seal design.



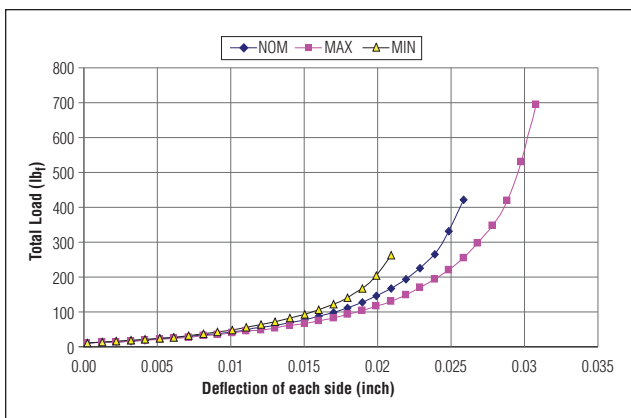
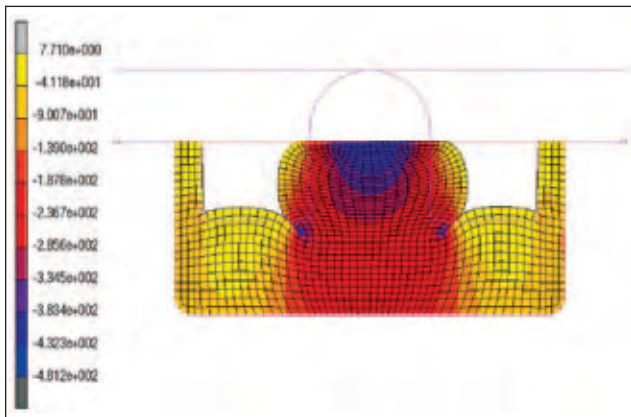

### 10. Assembly

The retainer permits extremely fast and sure installation. In fact, where volume dictates, the placement of the seal can be fully automated on a completely foolproof basis.

- Bolt retention: The rubber can be molded on the bolt holes for positive pre-assembly gripping and transporting. Retainer fits conveniently over bolts to hold the seal in place during assembly.
- Fast assembly
- Visually detectable after assembly

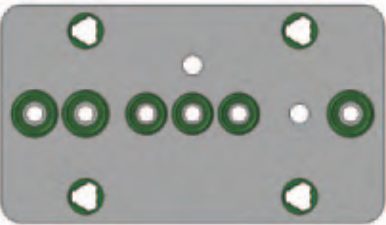

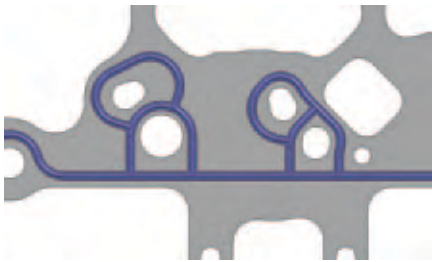
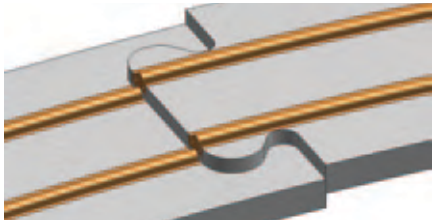
## Gask-O-Seal Configurations

Gask-O-Seal Design	Configuration	Features
Single-Port or Multi-Port Seal		<p>There is virtually no limit to the number of ports, compartments or chambers that can be sealed with a single plate-like package to facilitate simple and foolproof installation. This greatly reduces assembly time and missing seals. Prerequisites include sufficient flange hardware, strength and adequate bolting pattern and force to assure joint integrity during pressurization.</p>
Tandem or Redundancy Seal		<p>For “zero leakage” applications, a secondary companion groove and seal element parallel to the primary seal can be added. Note the leak-rate monitoring groove that can be provided between the two seals. The land width must be widened to accommodate dual seals.</p>
Contoured or Non-Planar Surface Seal		<p>The Gask-O-Seal can be molded into contoured, curved, non planar surfaces, even sharply bent corners, in some cases. This makes them ideal for sealing such applications as aircraft and missile nose cones, access doors, nacelles, industrial tanks, and similar curved structures. Curved Gask-O-Seals can be molded directly into structural components.</p>
Branched Seal		<p>Allows many barriers in one unit, saves space and weight, and accomplishes a variety of sealing missions with a manifold plate where it can handle differential pressures and different fluids for isolated ports and communication holes in either direction. This seal also greatly reduces assembly time.</p>
Segmented Seals		<p>Used for applications requiring very large Gask-O-Seals (&gt;60 inches in major dimension). This configuration helps reduce manufacturing and assembly costs. It has been used in critical aerospace applications where the sizes of seals can become extreme. It simplifies handling, packaging, and shipping. Segmented seals can also be designed with a redundant seal for more security.</p>
Multiple Materials		<p>Some applications require multiple materials for proper sealing. This may be due to chemical compatibility, permeation, or multiple ports with different fluids. Being able to incorporate different seal materials into the same retainer allows for optimization of the seal design vs. compromising with a single material selection. This feature should be discussed in detail with Composite Sealing Systems Division's engineering department.</p>

# Integral Seal





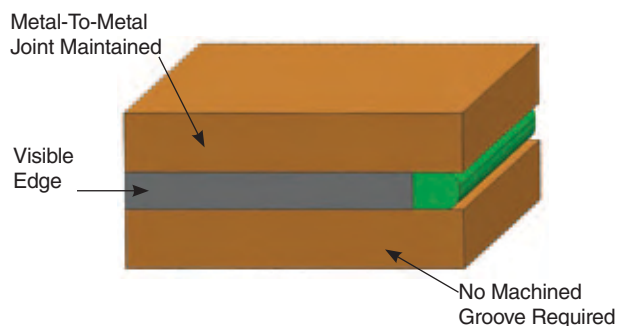
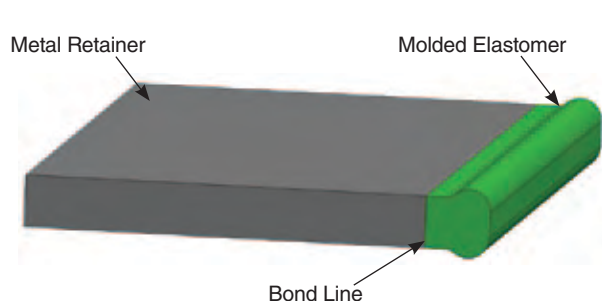

## About Integral Seal

The Integral Seal is so named because it effectively integrates a stamped or machined metal or molded plastic retainer with a molded-in-place rubber sealing element to create an extremely versatile sealing device.

The Integral Seal is custom designed, versatile and provides similar performance benefits seen with Parker's Gask-O-Seal. The Integral Seal lends itself to space constrained applications where overall seal

thickness may be of primary concern. Integral Seals can be manufactured in thickness as low as 0.012". The Integral Seals design also lends itself to high volume manufacturing methods making it a cost competitive option for high volume sealing applications. As shown below, the rubber sealing element is molded, and mechanically and/or chemically, bonded in place to the edge of the retainer.



Features		Benefits
Molded in Place		Sealing element precisely and permanently molded in place, allowing for ease of assembly. Secondary machining in mating hardware is not required to reduce hardware costs.
Visual Detection		Can be visually inspected to verify proper assembly. The integral seal concept offers the ultimate in quality assurance and joint integrity.
Bolt Retention		The rubber can be molded into the bolt holes for positive pre-assembly gripping and transporting.
Retrofit or New		The Integral Seal can be retrofitted to existing O-ring grooves or counterbores or it can be adapted to grooveless mating surfaces.
Point Loading of Seal		Permits reduced flange thickness, smaller bolts and bolt circle. The force required to load the Integral Seal metal to metal can be predetermined with closely controlled crown height and FEA.
Alternative Load Path		No retorquing required due to metal to metal contact. The load path is established through the metal retainer assuring positive closure and optimum bolt loading.

# Integral Seal Design Considerations

Once the seal type is determined the actual design for the Integral Seal can be started. There is a simple step by step method for designing an integral seal for your application. Here are the key points to consider:

## 1. Metal Thickness

Whenever possible, the metal thickness should be specified as a standard gauge callout with an accompanying standard stock thickness; i.e., Steel 11 gauge (.120" stock). This allows Parker to use materials that are readily available from suppliers and are most economical in producing the finished Integral Seal. Capabilities exist to go down to .012", however, metals with a thickness of less than .090" should be discussed with the Composite Sealing Systems Division's engineering department.

## 2. Dimensional Tolerances

In developing the overall design and establishing tolerances, the *non-critical* features, such as outline or outside dimensions, should have wide tolerances to reduce manufacturing costs. Bolt holes should have sufficient clearance around the bolts to permit reasonable locating tolerances. However, when the seal groove is located in relation to the bolt holes, the holes should be located within  $\varnothing$  .014 on small parts (<10 inches).

## 3. Bolting

In order to achieve optimum sealing, it is essential to provide sufficient flange preload and proper bolt size and spacing to create a metal to metal contact between the Integral Seal retainer and the mating parts. Under all service conditions, such as out-of-flat, system pressure, and rubber strength, the separation between flanges should *not* exceed .003" in order to prevent extrusion and damage to the elastomer. The force required to compress the seal is generally between 30 and 150 pounds per linear inch of seal, depending on the rubber durometer, material, and the configuration used. For larger gaps contact the Composite Sealing Systems Division's engineering department.

## 4. Surface Roughness

Surface roughness of the Integral Seal retainer itself is not critical to sealing. When a sheet metal retainer is used, the "as received" condition of the metal is satisfactory. On machined surfaces, Parker will maintain a roughness value of 125 micro-inch Ra or better. Callouts for finishes of the Integral Seal retainer with roughness less than 125 Ra can unnecessarily add to the part cost. For mating surfaces that the Integral Seal is to seal against, a 125 Ra or better will provide good sealing surfaces for almost all applications. The only notable exceptions are seals for gaseous media where diffusion type leakage must be kept to a minimum. For these installations, the mating surface should have a finish of 32 Ra or better.

## 5. Flatness and Parallelism

In most cases, no particular attention needs to be given to flatness and parallelism requirements. Occasionally the Integral Seal is used between two halves of a device that must be accurately, aligned such as a gear box housing. For this, the mating surfaces must be parallel within close tolerances.

## 6. Flange Separation

When pressure is applied to a separable joint of any kind (e.g. flanges, lids, covers, etc.) there is a tendency for the mating surfaces to separate or "gap." This gap can result in extrusion, wear and failure of the seal element. Ascertain whether the existing flanges or covers separate, gap, or bulge during pressurization and/or cycling. This will determine seal cross-section, crown height, style, and re-enforcement required once you know the magnitude.

## 7. Types of Bond

During the molding-in-place process, the carefully designed seal element is either chemically bonded to and/or mechanically interlocked with the edge of the metal (or plastic) retainer.

- **Chemical Bonding**

For the sizes equal to or larger than 1" inside diameter, a chemically bonded retention of the rubber seal element is provided. This bonding takes place during the actual molding-in-place of the rubber via a process called co-vulcanization. This assures excellent adhesion of the seal element.

- **Mechanical Interlocking**

A unique mechanical type retention of the molded-in-place rubber to the metal retainer is available. During the stamping operation, the inside of the retainer/washer is splined and then coined to provide a series of interlocking openings for the securing of the rubber as it vulcanizes in place.

## 8. Retrofit with Parker's Integral Seal

Integral Seals can be adapted to retrofit existing flange designs that already have an O-ring groove or counterbore for complete interchangeability. The retainer thickness can be reduced to as low as .012" to facilitate retrofitting in previously grooved flanged surfaces.



# Integral Seal

## Integral Seal Design Considerations, *Continued*

### 9. Finite Element Analysis (FEA)

The study of elastomer stress and its relationship to seal effectiveness has been dramatically enhanced with the advent of finite element analysis. FEA is a numerical modeling technique used to predict a deformation and stress concentration of a given seal cross section. Parameters such as cross section geometry and material property data are factored into the modeling equation to produce a stress concentration model of the seal. FEA is effective as a predictor of seal performance only when it is used in conjunction with historical seal and material data and specific performance testing. Please consult the division if FEA is being considered as a tool for seal design.

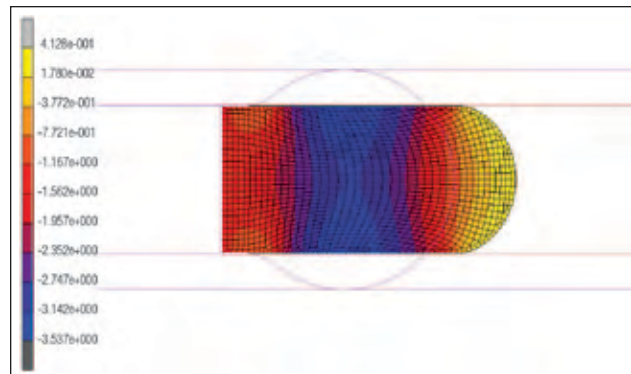

### 10. Assembly

The retainer permits extremely fast and sure installation. In fact, where volume dictates, the placement of the seal can be fully automated on a completely foolproof basis.

- Bolt retention: The rubber can be molded on the bolt holes for positive pre-assembly gripping and transporting. Retainer fits conveniently over bolts to hold the seal in place during assembly the seal cannot fallout.
- Fast assembly
- No blow out
- Visually detectable after assembly
- Resists extrusion under high pressure and flange separation

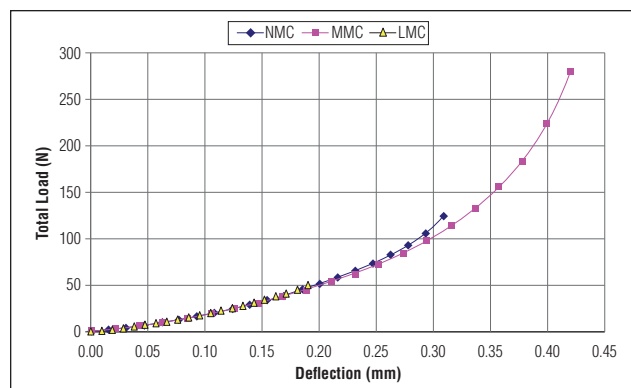





## Integral Seal Configurations

There are five Integral Seal types to suit specific customer design requirements. Like the Gask-O-Seal, configurations available to the user are quite varied and are limited only by retainer dimensions and space considerations. It is even possible to segment certain Integral

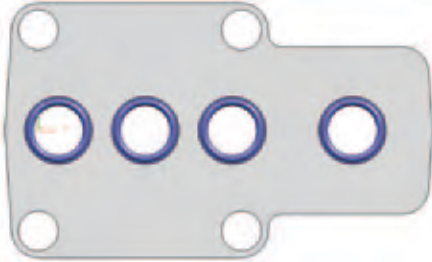
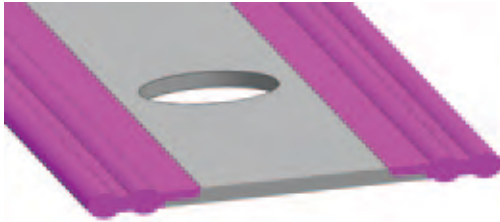
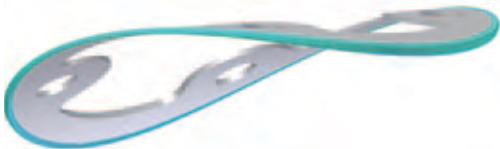
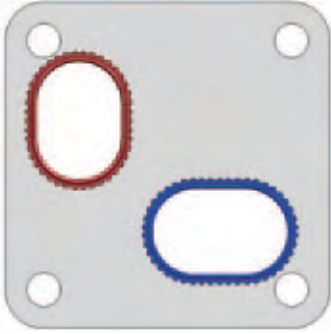
Seal styles using a Parker devised tongue-and-groove arrangement to seal extra large layouts. Consult the division for further details concerning such special applications.

Integral Seal Design	Configuration	Features
Single-Port or Multi-Port Seal		There is virtually no limit to the number of ports that can be sealed with a single Integral Seal to facilitate simple and foolproof installation. This greatly reduces assembly time and the risk of a missing seal. Sufficient land area is needed between ports to incorporate the retainer as well as the elastomer.
Redundancy Seal		For “zero leakage” applications, a secondary seal element parallel to the primary seal can be added. This type of design requires a larger amount of land area on the mating hardware to ensure proper squeeze across both beads.
Contoured or Non-Planar Surface Seal		Parker currently designs and manufactures several Integral Seals used in contoured applications. Because the retainer of the Integral Seal can be so much thinner compared to the Gask-O-Seal, it's possible to bend the retainer during assembly and ensure intimate contact between two non-planar surfaces. This should be discussed in detail with the Composite Sealing Systems Division's engineering department during the design phase.
Multiple Material		Some applications require multiple materials for proper sealing. This may be due to chemical compatibility, permeation, or multiple ports with different fluids. Being able to incorporate different seal materials into the same retainer allows for optimization of the seal design vs. compromising with a single material selection. This feature should be discussed in detail with Composite Sealing Systems Division's engineering department.
Retrofit Seal		A retrofit Integral Seal can be designed for applications that have O-ring grooves in their hardware. It is extremely helpful in high pressure situations where the O-ring simply cannot handle the pressure or when the customer has a difficult time determining if there is a missing seal at the end of the assembly operation.

# Technical Data and Product Information

## Chemical Compatibility Guide

This information is provided for reference only. Always test under actual conditions.

Compound Compatibility Rating 1: Satisfactory 2: Fair 3: Doubtful 4: Unsatisfactory X: Insufficient Data	Nitrile NBR	Ethylene Propylene EPDM	Fluorocarbon FKM	Hifluor FKM	Perfluoroelastomer FFKM	Neoprene CR	Butyl IIR	Fluorosilicone FVMQ	Silicone VMQ
Acetic Acids, 5%	2	1	1	1	1	1	1	2	1
Acetone	4	1	4	2	1	4	1	4	4
Acids, Non-Organic	X	X	X	1	1	X	X	X	X
Acids, Organic	X	X	X	1	1	X	X	X	X
Air	2	1	1	1	1	1	1	1	1
Amines	4	2	4	3	2	2	2	4	2
Ammonia	2	1	4	3	2	1	1	4	2
ASTM Oil 1	1	4	1	1	1	1	4	1	1
ASTM Oil 2	1	4	1	1	1	2	4	1	4
ASTM Oil 3	1	4	1	1	1	4	4	1	3
ASTM Oil 4	2	4	1	1	1	4	4	2	4
ASTM Oil 5	1	4	1	1	1	2	X	X	X
ASTM Reference Fuel A	1	4	1	1	1	2	4	1	4
ASTM Reference Fuel B	1	4	1	1	1	4	4	1	4
ASTM Reference Fuel C	2	4	1	1	1	4	4	2	4
ASTM Reference Fuel D	2	4	1	1	1	4	X	X	X
Auto Brake Fluid	3	1	4	1	1	2	2	4	3
Beer	1	1	1	1	1	1	1	1	1
Bleach	X	1	1	1	1	X	X	X	X
Blood	2	1	1	1	1	1	X	X	X
Brake Fluid DOT	3	1	4	1	1	2	2	4	3
Brine	1	1	1	1	1	X	X	X	X
Butane	1	4	1	1	1	1	4	3	4
Butter	1	1	1	1	1	2	3	X	2
Carbolic Acid (Phenol)	4	2	1	1	1	4	2	1	4
Carbonic Acid	2	1	1	1	1	1	1	1	1
Castor Oil	1	2	1	1	1	1	2	1	1
Caustic Lime	3	1	3	1	1	1	1	1	2
Caustic Soda	3	1	3	1	1	1	1	1	2
Chloramine	X	X	X	1	1	X	X	X	X
Chloric Acid	3	1	3	1	1	1	1	1	2
Chlorinated Solvents	4	4	1	1	1	4	4	1	4
Chlorine	2	4	1	1	1	4	4	2	X
Chloroform	4	4	1	1	1	4	4	4	4

Compound Compatibility Rating 1: Satisfactory 2: Fair 3: Doubtful 4: Unsatisfactory X: Insufficient Data	Nitrile NBR	Ethylene Propylene EPDM	Fluorocarbon FKM	Hifluor FKM	Perfluoroelastomer FFKM	Neoprene CR	Butyl IIR	Fluorosilicone FVMQ	Silicone VMQ
Chlorox	2	1	1	1	1	2	2	1	X
Citric Acid	1	1	1	1	1	1	1	1	1
Codeine	2	4	1	1	1	4	4	2	X
Crude Oil	2	4	1	1	1	4	4	2	4
Cyanides	X	X	1	1	1	X	X	X	X
DDT	2	4	1	1	1	4	4	2	X
Detergent	1	1	1	1	1	2	1	1	1
DI Water	2	1	2	1	1	1	1	1	2
Diesel Fuel	1	4	1	1	1	3	4	1	4
Di-ester Synthetic Lubricants	2	4	1	1	1	4	4	2	4
Dry cleaning Fluids	3	4	1	1	1	4	4	2	4
Ethane	1	4	1	1	1	2	4	3	4
Ethanol	3	1	3	1	1	1	1	1	2
Ethers	4	3	3	1	1	4	4	3	4
Fluorine	4	4	2	2	2	X	X	X	X
Formaldehyde	3	2	4	1	1	3	2	4	2
Freon R134a	1	1	4	4	3	1	X	4	4
Fuel Oil	2	4	1	1	1	4	4	1	1
Gasoline	1	4	1	1	1	4	4	1	4
Gluconic Acid	3	1	3	1	1	1	1	1	2
Glucose	1	1	1	1	1	1	1	1	1
Glue	X	X	X	1	1	X	X	X	X
Glycerin	1	1	1	1	1	1	1	1	1
Glycol	1	1	1	1	1	1	1	1	1
Grease, Petroleum Base	1	4	1	1	1	3	4	1	4
Hannifin Lube A	1	4	1	1	1	1	4	1	2
Helium	1	1	1	1	1	1	1	1	1
Hydraulic Oils, Petroleum Base	1	4	1	1	1	2	4	1	2
Hydraulic Oils, Synthetic Base	2	4	1	1	1	4	4	2	X
Hydrochloric Acid	4	3	1	1	1	4	4	2	X
Hydrogen Gas	1	1	1	1	1	1	1	3	3
Hydrogen Peroxide	2	1	1	1	1	1	1	1	1
Hydrogen Sulfide	4	1	4	1	1	2	1	3	3
Insulin	3	1	3	1	1	1	1	1	2

Compound Compatibility Rating 1: Satisfactory 2: Fair 3: Doubtful 4: Unsatisfactory X: Insufficient Data	Nitrile NBR	Ethylene Propylene EPDM	Fluorocarbon FKM	Hifluor FKM	Perfluoroelastomer FFKM	Neoprene CR	Butyl IIR	Fluorosilicone FVMQ	Silicone VMQ
Iodine	2	2	1	1	1	4	2	4	X
Isopropyl Alcohol (IPA)	2	1	1	1	1	2	1	2	1
Jet fuel, A	2	4	1	1	1	4	4	2	X
Kerosene	1	4	1	1	1	2	4	1	4
Lactic Acid	4	4	1	1	1	4	4	2	2
Liquid Oxygen (LOX)	4	4	4	3	2	4	4	4	4
Liquid Petroleum Gas (LPG)	1	4	1	1	1	2	4	1	3
Lubricating Oils, Crude & Refined	2	4	1	1	1	3	X	X	X
Lubricating Oils, Synthetic Base	X	X	1	1	1	4	4	2	X
Lubricating Oils, Di-ester	2	4	1	1	1	3	4	2	4
Lubricating Oils, Petroleum Base	1	4	1	1	1	2	4	1	4
Lubricating Oils, SAE 10, 20, 30, 40, 50	1	4	1	1	1	2	4	1	4
Lye Solutions	2	1	2	1	1	2	1	2	2
Methane	1	4	1	1	1	2	4	3	4
Methanol	4	1	4	1	1	1	1	1	1
Methyl Ethyl Ketone (MEK)	4	1	4	2	1	4	1	4	4
Mineral Oils	1	3	1	1	1	2	3	1	2
Motor Oils	1	4	1	1	1	2	4	1	2
Morphine	X	1	1	X	1	X	X	X	1
Natural Gas	1	4	1	1	1	1	4	3	4
Neon	1	1	1	1	1	1	1	1	1
Nicotine	X	X	1	1	1	4	4	2	X
Nitrogen	1	1	1	1	1	1	1	1	1
Nitrous Acid	3	1	3	1	1	1	1	1	2
Nitrous Oxide	1	1	1	1	1	X	X	X	1
Octane	1	4	1	1	1	4	4	2	4
Oxygen, Liquid	4	4	4	3	2	4	X	X	X
Ozone	4	1	1	1	1	2	2	1	1
Paint Thinner	4	4	2	1	1	4	4	2	4
Paraffins	1	4	1	1	1	2	4	1	2
Parker O-Lube	1	4	1	1	1	1	4	1	2
Penicillin	X	X	1	1	1	4	4	2	X
Petroleum Oil, Crude	1	4	1	1	1	2	4	1	4
Phenol	4	4	1	1	1	4	4	2	4

Compound Compatibility Rating 1: Satisfactory 2: Fair 3: Doubtful 4: Unsatisfactory X: Insufficient Data	Nitrile NBR	Ethylene Propylene EPDM	Fluorocarbon FKM	Hifluor FKM	Perfluoroelastomer FFKM	Neoprene CR	Butyl IIR	Fluorosilicone FVMQ	Silicone VMQ
Producer Gas	1	4	1	1	1	2	4	2	2
Propane	1	4	1	1	1	2	4	2	4
Radiation	3	2	4	3	2	X	4	4	2
Sea Water	1	1	1	1	1	2	1	1	1
Sewage	1	1	1	1	1	2	1	1	1
Silicone Greases	1	1	1	1	1	1	1	2	3
Silicone Oils	1	1	1	1	1	1	1	3	3
Skydrol	4	1	4	1	1	4	2	3	3
Soap Solutions	1	1	1	1	1	2	1	1	1
Sour Crude Oils	3	4	1	1	1	4	4	4	4
Sour Natural Gas	3	4	1	1	1	4	4	4	4
Steam, Below 400F	4	1	4	1	1	4	2	4	3
Steam, 400F – 500F	4	3	4	1	1	4	4	4	4
Steam, Above 500F	X	X	X	1	1	X	X	X	X
Stearic Acid	2	2	X	1	1	2	2	X	2
Sulfur	4	1	1	1	1	1	1	1	X
Sulfuric Acid	X	3	1	1	1	X	X	X	X
Thiokol	4	1	1	1	1	2	1	2	X
Toluene	4	4	1	2	1	4	4	2	4
Transformer Oils	1	4	1	1	1	2	4	1	2
Transmission Fluids	1	4	1	1	1	2	4	1	2
Turbine Oils	1	4	1	1	1	4	4	1	4
Turbo Oils	1	4	1	1	1	2	4	1	4
Type I Fuel	1	4	1	1	1	2	4	1	4
Type II Fuel	2	4	1	1	1	4	4	2	4
Type III Fuel	2	4	1	1	1	4	4	2	4
Water	1	1	2	1	1	2	1	1	1

For a complete list of chemical compatibility, please see Parker's O-Ring Handbook (ORD 5700).

# Technical Data and Product Information

## Leak Rate Criteria

Fundamental to the design of any efficient seal is the leakage rate. When properly used in sealing liquids, a Gask-O-Seal or Integral Seal will provide true zero leakage. This term means that there is no detectable leakage of a liquid over a given period of time. Gases, on the other hand, will diffuse through the rubber at some very low rate that can be detected by a leak detector, a mass spectrometer or other very sensitive measuring device. The rate depends primarily on the temperature, squeeze percentage, the pressure differential, the type of gas and the type of elastomer used. Table 1 gives stabilized helium leak rates for four compounds for various temperatures at one atmosphere pressure differential of helium. Consideration of leakage rate is of major importance in the sealing of vacuum.

Hard vacuum (vacuum below the level of  $10^{-6}$  mm Hg (torr) affects materials in two general ways. First, the material contains adsorbed gases which may be removed by outgassing. Secondly, vaporization or sublimation (sublimation is a phenomenon whereby a solid material changes directly into a gas) of the material or of a volatile component of the material may occur. The rates of the reactions can be radically affected by temperature. In addition, high vacuum may cause alteration of the seal structure, affecting its physical properties. Outgassing, vaporization and/or sublimation of rubber in a vacuum system can cause seal shrinkage and deterioration of the seal material.

It was generally thought in the past that all elastomers had vapor pressures between  $10^{-4}$  and  $10^{-9}$  torr and would therefore all sublime or vaporize selectively as these pressures were reached in a hard vacuum system. However, Parker sponsored research programs showed that this was not necessarily true. Sublimation where it did occur was found to be a surface effect. Though the sample was eroded on the surface, it did not completely sublime. Other specially compounded elastomers were developed that were not affected, at vacuums of  $10^{-9}$  torr. It was also found that temperatures can have a significant effect on sublimation rates. Data showing the effect of hard vacuum temperatures on seal materials are given in *table 2*.

**Table 1: Gask-O-Seal Vacuum Leak Rate at 1 ATM Pressure\*\*\***

Elastomer	Stabilized Leak Rate Range (ATM cc/in/yr* He)**		
	25°C (77°F)	80°C (176°F)	150°C (302°F)
Butyl	1.0 to 3.0	3.0 to 9.0	N/A
Fluorocarbon	2.0 to 6.0	4.5 to 18.0	6.1 to 28.0
Ethylene Propylene	6.3 to 19.0	33.4 to 100	104 to 310
Silicone	49.3 to 150	126 to 380	269 to 810

\* Atmospheric cubic centimeters of Helium per linear inch of seal per year

\*\* Test results of 460-xxx-16 series Gask-O-Seal (302/304 SS retainers)

\*\*\* Tested with Helium at one atmosphere pressure inside the seal, and an average absolute pressure of  $3.5 \times 10^{-7}$  torr outside seal

Recent studies of actual applications indicate that allowances must be made for the limit of accuracy of leak detection apparatus and normal variations which affect the seal such as; bolt spacing, flange separation, surface finish, etc. Therefore, in most applications it is recommended that the high limit leak rate as noted in table 1 (three times the low limit) be used as the predicted stabilized leak rate for actual service conditions. These values may be exceeded if the mating surface is too rough, if flanges separate, or if the components are not sufficiently clean.

One word of caution is in order. When applying the leak rate data of table 1 to a specific seal design, multiply the linear inches of seal line by the diffusion rate. A two sided seal has twice the seal length of a single sided seal. Also, for higher temperatures, greater pressure differentials, or compounds other than shown, the rates will change. In these cases, tolerable leak rates of gases should be specified.

For moderate temperature use and vacuum levels from slightly below atmospheric pressure to vacuums approaching  $1 \times 10^{-3}$  torr, special precautions in the Gask-O-Seal design are seldom necessary. In the "high vacuum" range, from  $1 \times 10^{-3}$  torr, to levels close to  $1 \times 10^{-6}$  torr, special manufacturing techniques must be employed to assure an acceptably low leak rate. Be sure therefore, that Parker is notified of the vacuum level for applications in this range.

When parts produced for vacuum use are received, they should remain in the sealed containers until nearly time for use. They should then be thoroughly cleaned, particularly the elastomeric seal portion, by wiping with a lint-free cloth, lightly moistened with isopropyl alcohol, methanol, or other solvent that will not damage the elastomer. For very high vacuum levels, mating parts should have a surface finish of 16 RMS or smoother.

**NOTE:** It is recommended to install the Gask-O-Seal or Integral Seal dry as it comes from the package. **DO NOT LUBRICATE**, or install beneath liquids. For vacuum seals, a very thin film of vacuum grease may be applied to the mating surfaces or very lightly applied to the seal crown only.

**Table 2: Weight Loss Under Vacuum as a Function of Temperature**

Elastomer	Temperature °F	Weight Loss %	Pressure TORR
Butyl <sup>1</sup>	75	3.3	$6 \times 10^{-8}$
	120	5.1	$2 \times 10^{-8}$
	165	6.8	$3 \times 10^{-8}$
Fluorocarbon <sup>1</sup>	75	0	$1 \times 10^{-8}$
	120	0.7	$4 \times 10^{-8}$
	165	1.3	$5 \times 10^{-8}$
Ethylene Propylene <sup>2</sup>	75	0.4	$4 \times 10^{-8}$

1. Duration of test, 8 days
2. Duration of test, 24 days

## Bolt Sizes and Torque Values

See the table below for suggested approximate torque values for fasteners of different materials. The baseline torque is calculated for a non-lubricated and un-plated bolt.

Suggested Assembly Torque Values For Fasteners of Different Materials (Torque in lbs-ft)					
Coarse Thread					
Bolt Size	Grade 2 Steel	Grade 5 Steel	Grade 8 Steel	316 Stainless Steel	2024-T4 Aluminum
1/4-20	4	8	12	7	4
5/16-18	9	17	25	12	7
3/8-16	16	30	45	21	12
7/16-14	24	50	70	33	19
1/2-13	38	75	110	45	26
9/16-12	52	110	150	60	34
5/8-11	98	150	220	97	60
3/4-10	157	260	380	132	82
7/8-9	210	430	600	203	125
1-8	320	640	900	300	184
Fine Thread					
Bolt Size	Grade 2 Steel	Grade 5 Steel	Grade 8 Steel	316 Stainless Steel	2024-T4 Aluminum
1/4-28	6	10	14	8	5
5/16-24	12	19	29	12	7
3/8-24	22	35	50	23	13
7/16-20	34	55	80	35	20
1/2-20	52	90	120	47	27
9/16-18	71	120	170	66	38
5/8-18	115	180	240	108	67
3/4-16	180	300	420	130	80
7/8-14	230	470	660	202	124
1-14	350	710	990	271	166

The above estimated torque values are offered as a guide only. Use of its content by anyone is the sole responsibility of that person and they assume all risk. The only way to determine the correct torque is through experimentation under actual joint and assembly conditions.

Torques values can be calculated based on the following relationship:

$$T = K \cdot D \cdot P$$

Where: T = Torque (lbs-in)

D = Nominal Diameter (in)

P = Clamp Load (lbs)

K = Torque Friction Coefficient

The value of K is assumed to be equal to .20 for dry, unplated conditions and equal to .15 for lubricated, including plated conditions. Actual values of K can vary between .05 and .35 for commonly encountered conditions.

The above torque values can be used to calculate approximately the bolt clamp load in pounds as follows:

$$\text{Clamp Load (lbs)} = T / (K \cdot D)$$

**Total Clamp Load (lbs) = N \* T / (K \* D), where N is total number of bolts**

Example: SAE Grade 5 Steel, Bolt 5/8"-18 size:

$$\text{Bolt Loading Force} = (1 \cdot 180) / (.20 \cdot .625) = 1,440 \text{ lbs.}$$

# Technical Data and Product Information

## Application Data Form

<b>Customer Information:</b>	
Name: _____	Title: _____
Company: _____	
Address: _____	City: _____ State: _____ Zip: _____
Email: _____	Phone: _____ Fax: _____
<b>Distributor:</b>	
Distributor Name: _____	Contact Name: _____
Address: _____	City: _____ State: _____ Zip: _____
Email: _____	Phone: _____ Fax: _____
<b>Product Information:</b> ( <input type="checkbox"/> New/ <input type="checkbox"/> Existing) Problem: <input type="checkbox"/> Leakage <input type="checkbox"/> Life <input type="checkbox"/> Cost <input type="checkbox"/> Other _____	
Market: <input type="checkbox"/> Aerospace <input type="checkbox"/> Automotive <input type="checkbox"/> Chemical Processing <input type="checkbox"/> Commercial <input type="checkbox"/> EOG <input type="checkbox"/> Industrial <input type="checkbox"/> Life Sciences <input type="checkbox"/> Military <input type="checkbox"/> Semiconductor <input type="checkbox"/> Other _____	
Program: _____	Application: _____
Existing Sealing Type/Materials: _____	Competition: _____
Current Price: _____	Target Price: _____ Program Start Date: _____ Ramp Schedule: _____
Quantity: Prototype: _____	Production: _____ Annual Usage: _____
<b>Operating Conditions:</b>	
Media: _____	Gas/Liq/Sol: _____ Visc.: _____ Allow. Leakage: _____
Temperature: Operating: _____	Min.: _____ Max.: _____
Pressure: (Check all that apply) <input type="checkbox"/> Pressure <input type="checkbox"/> Vacuum <input type="checkbox"/> Internal <input type="checkbox"/> External	
Operating: _____	Min.: _____ Max.: _____ Proof: _____
<b>Hardware Conditions:</b> ( <input type="checkbox"/> New/ <input type="checkbox"/> Existing) Drawing Number(s): _____	
Flange: Material: _____	Surface Hardness: _____ Finish: _____ Flatness: _____
Cover: Material: _____	Surface Hardness: _____ Finish: _____ Flatness: _____
<b>Specifications/Requirements:</b>	
Material Spec.: Compound(s): _____	Retainer: _____
Finish Spec.: _____	Cleaning Spec.: _____
Identification: Mark Bag: _____	Mark Part: _____ Spec.: _____
Marking Information: _____	
Testing Spec.: _____	
Export Controlled: <input type="checkbox"/> Yes <input type="checkbox"/> No	

Please fax or email a copy of the completed application data form along with any pertinent information (i.e. hardware drawings) to the Composite Sealing Systems Division marketing/sales department.

# Offer of Sale

The items described in this document and other documents and descriptions provided by Parker Hannifin Corporation, its subsidiaries and its authorized distributors ("Seller") are hereby offered for sale at prices to be established by Seller. This offer and its acceptance by any customer ("Buyer") shall be governed by all of the following Terms and Conditions. Buyer's order for any item described in its document, when communicated to Seller verbally, or in writing, shall constitute acceptance of this offer. All goods or work described will be referred to as "Products".

1. Terms and Conditions. Seller's willingness to offer Products, or accept an order for Products, to or from Buyer is expressly conditioned on Buyer's assent to these Terms and Conditions and to the terms and conditions found on-line at [www.parker.com/saleterms/](http://www.parker.com/saleterms/). Seller objects to any contrary or additional term or condition of Buyer's order or any other document issued by Buyer.

2. Price Adjustments; Payments. Prices stated on the reverse side or preceding pages of this document are valid for 30 days. After 30 days, Seller may change prices to reflect any increase in its costs resulting from state, federal or local legislation, price increases from its suppliers, or any change in the rate, charge, or classification of any carrier. The prices stated on the reverse or preceding pages of this document do not include any sales, use, or other taxes unless so stated specifically. Unless otherwise specified by Seller, all prices are F.O.B. Seller's facility, and payment is due 30 days from the date of invoice. After 30 days, Buyer shall pay interest on any unpaid invoices at the rate of 1.5% per month or the maximum allowable rate under applicable law.

3. Delivery Dates; Title and Risk; Shipment. All delivery dates are approximate and Seller shall not be responsible for any damages resulting from any delay. Regardless of the manner of shipment, title to any products and risk of loss or damage shall pass to Buyer upon tender to the carrier at Seller's facility (i.e., when it's on the truck, it's yours). Unless otherwise stated, Seller may exercise its judgment in choosing the carrier and means of delivery. No deferment of shipment at Buyer's request beyond the respective dates indicated will be made except on terms that will indemnify, defend and hold Seller harmless against all loss and additional expense. Buyer shall be responsible for any additional shipping charges incurred by Seller due to Buyer's changes in shipping, product specifications or in accordance with Section 13, herein.

4. Warranty. Seller warrants that the Products sold hereunder shall be free from defects in material or workmanship for a period of twelve months from the date of delivery to Buyer or 2,000 hours of normal use, whichever occurs first. This warranty is made only to Buyer and does not extend to anyone to whom Products are sold after purchased from Seller. The prices charged for Seller's products are based upon the exclusive limited warranty stated above, and upon the following disclaimer: Disclaimer of Warranty: This warranty comprises the sole and entire warranty pertaining to products provided hereunder. SELLER DISCLAIMS ALL OTHER WARRANTIES, EXPRESS AND IMPLIED, INCLUDING MERCHANTABILITY AND FITNESS FOR A PARTICULAR PURPOSE.

5. Claims; Commencement of Actions. Buyer shall promptly inspect all Products upon delivery. No claims for shortages will be allowed unless reported to the Seller within 10 days of delivery. No other claims against Seller will be allowed unless asserted in writing within 60 days after delivery or, in the case of an alleged breach of warranty, within 30 days after the date within the warranty period on which the defect is or should have been discovered by Buyer. Any action based upon breach of this agreement or upon any other claim arising out of this sale (other than an action by Seller for any amount due to Seller from Buyer) must be commenced within thirteen months from the date of tender of delivery by Seller or, for a cause of action based upon an alleged breach of warranty, within thirteen months from the date within the warranty period on which the defect is or should have been discovered by Buyer.

6. LIMITATION OF LIABILITY. UPON NOTIFICATION, SELLER WILL, AT ITS OPTION, REPAIR OR REPLACE A DEFECTIVE PRODUCT, OR REFUND THE PURCHASE PRICE. IN NO EVENT SHALL SELLER BE LIABLE TO BUYER FOR ANY SPECIAL, INDIRECT, INCIDENTAL OR CONSEQUENTIAL DAMAGES ARISING OUT OF, OR AS THE RESULT OF, THE SALE, DELIVERY, NON-DELIVERY, SERVICING, USE OR LOSS OF USE OF THE PRODUCTS OR ANY PART THEREOF, OR FOR ANY CHARGES OR EXPENSES OF ANY NATURE INCURRED WITHOUT SELLER'S WRITTEN CONSENT, EVEN IF SELLER HAS BEEN NEGLIGENT, WHETHER IN CONTRACT, TORT OR OTHER LEGAL THEORY. IN NO EVENT SHALL SELLER'S LIABILITY UNDER ANY CLAIM MADE BY BUYER EXCEED THE PURCHASE PRICE OF THE PRODUCTS.

7. Contingencies. Seller shall not be liable for any default or delay in performance if caused by circumstances beyond the reasonable control of Seller.

8. User Responsibility. The user, through its own analysis and testing, is solely responsible for making the final selection of the system and Product and assuring that all performance, endurance, maintenance, safety and warning requirements of the application are met. The user must analyze all aspects of the application and follow applicable industry standards and Product information. If Seller provides Product or system options, the user is responsible for determining that such data and specifications are suitable and sufficient for all applications and reasonably foreseeable uses of the Products or systems.

9. Loss to Buyer's Property. Any designs, tools, patterns, materials, drawings, confidential information or equipment furnished by Buyer or any other items which become Buyer's property, may be considered obsolete and may be destroyed by Seller after two consecutive years have elapsed without Buyer placing an order for the items which are manufactured using such property. Seller shall not be responsible for any loss or damage to such property while it is in Seller's possession or control.

10. Special Tooling. A tooling charge may be imposed for any special tooling, including without limitation, dies, fixtures, molds and patterns, acquired to manufacture Products.

Such special tooling shall be and remain Seller's property notwithstanding payment of any charges by Buyer. In no event will Buyer acquire any interest in apparatus belonging to Seller which is utilized in the manufacture of the Products, even if such apparatus has been specially converted or adapted for such manufacture and notwithstanding any charges paid by Buyer. Unless otherwise agreed, Seller shall have the right to alter, discard or otherwise dispose of any special tooling or other property in its sole discretion at any time.

11. Buyer's Obligation; Rights of Seller. To secure payment of all sums due or otherwise, Seller shall retain a security interest in the goods delivered and this agreement shall be deemed a Security Agreement under the Uniform Commercial Code. Buyer authorizes Seller as its attorney to execute and file on Buyer's behalf all documents Seller deems necessary to perfect its security interest. Seller shall have a security interest in, and lien upon, any property of Buyer in Seller's possession as security for the payment of any amounts owed to Seller by Buyer.

12. Improper use and Indemnity. Buyer shall indemnify, defend, and hold Seller harmless from any claim, liability, damages, lawsuits, and costs (including attorney fees), whether for personal injury, property damage, patent, trademark or copyright infringement or any other claim, brought by or incurred by Buyer, Buyer's employees, or any other person, arising out of: (a) improper selection, improper application or other misuse of Products purchased by Buyer from Seller; (b) any act or omission, negligent or otherwise, of Buyer; (c) Seller's use of patterns, plans, drawings, or specifications furnished by Buyer to manufacture Product; or (d) Buyer's failure to comply with these terms and conditions. Seller shall not indemnify Buyer under any circumstance except as otherwise provided.

13. Cancellations and Changes. Orders shall not be subject to cancellation or change by Buyer for any reason, except with Seller's written consent and upon terms that will indemnify, defend and hold Seller harmless against all direct, incidental and consequential loss or damage. Seller may change product features, specifications, designs and availability with notice to Buyer.

14. Limitation on Assignment. Buyer may not assign its rights or obligations under this agreement without the prior written consent of Seller.

15. Entire Agreement. This agreement contains the entire agreement between the Buyer and Seller and constitutes the final, complete and exclusive expression of the terms of the agreement. All prior or contemporaneous written or oral agreements or negotiations with respect to the subject matter are herein merged.

16. Waiver and Severability. Failure to enforce any provision of this agreement will not waive that provision nor will any such failure prejudice Seller's right to enforce that provision in the future. Invalidation of any provision of this agreement by legislation or other rule of law shall not invalidate any other provision herein. The remaining provisions of this agreement will remain in full force and effect.

17. Termination. This agreement may be terminated by Seller for any reason and at any time by giving Buyer thirty (30) days written notice of termination. In addition, Seller may by written notice immediately terminate this agreement for the following: (a) Buyer commits a breach of any provision of this agreement (b) the appointment of a trustee, receiver or custodian for all or any part of Buyer's property (b) the filing of a petition for relief in bankruptcy of the other Party on its own behalf, or by a third party (c) an assignment for the benefit of creditors, or (d) the dissolution or liquidation of the Buyer.

18. Governing Law. This agreement and the sale and delivery of all Products hereunder shall be deemed to have taken place in and shall be governed and construed in accordance with the laws of the State of Ohio, as applicable to contracts executed and wholly performed therein and without regard to conflicts of laws principles. Buyer irrevocably agrees and consents to the exclusive jurisdiction and venue of the courts of Cuyahoga County, Ohio with respect to any dispute, controversy or claim arising out of or relating to this agreement. Disputes between the parties shall not be settled by arbitration unless, after a dispute has arisen, both parties expressly agree in writing to arbitrate the dispute.

19. Indemnity for Infringement of Intellectual Property Rights. Seller shall have no liability for infringement of any patents, trademarks, copyrights, trade dress, trade secrets or similar rights except as provided in this Section. Seller will defend and indemnify Buyer against allegations of infringement of U.S. patents, U.S. trademarks, copyrights, trade dress and trade secrets ("Intellectual Property Rights"). Seller will defend at its expense and will pay the cost of any settlement or damages awarded in an action brought against Buyer based on an allegation that a Product sold pursuant to this Agreement infringes the Intellectual Property Rights of a third party. Seller's obligation to defend and indemnify Buyer is contingent on Buyer notifying Seller within ten (10) days after Buyer becomes aware of such allegations of infringement, and Seller having sole control over the defense of any allegations or actions including all negotiations for settlement or compromise. If a Product is subject to a claim that it infringes the Intellectual Property Rights of a third party, Seller may, at its sole expense and option, procure for Buyer the right to continue using the Product, replace or modify the Product so as to make it noninfringing, or offer to accept return of the Product and return the purchase price less a reasonable allowance for depreciation. Notwithstanding the foregoing, Seller shall have no liability for claims of infringement based on information provided by Buyer, or directed to Products delivered hereunder for which the designs are specified in whole or part by Buyer, or infringements resulting from the modification, combination or use in a system of any Product sold hereunder. The foregoing provisions of this Section shall constitute Seller's sole and exclusive liability and Buyer's sole and exclusive remedy for infringement of Intellectual Property Rights.

20. Taxes. Unless otherwise indicated, all prices and charges are exclusive of excise, sales, use, property, occupational or like taxes which may be imposed by any taxing authority upon the manufacture, sale or delivery of Products.

21. Equal Opportunity Clause. For the performance of government contracts and where dollar value of the Products exceed \$10,000, the equal employment opportunity clauses in Executive Order 11246, VEVRAA, and 41 C.F.R. §§ 60-1.4(a), 60-741.5(a), and 60-250.4, are hereby incorporated.

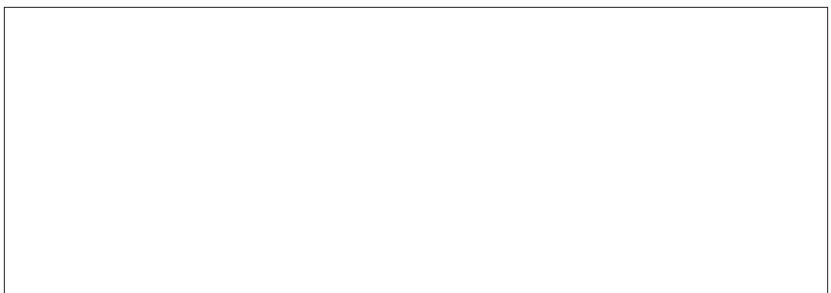

Your Local Authorized Parker Distributor



Parker Hannifin Corporation  
**Composite Sealing Systems Division**  
7664 Panasonic Way  
San Diego, CA 92154  
Phone: 619 661 7000  
fax: 619 671 3202